

Refrigerant Connection	
Factory Charge (kg)	2.85
Piping Distance (m)	3 - 30
Add. Charge >10 m (m)	50
Gas Pipe Diameter (mm(in))	5/8
Liquid Pipe Diameter (mm(in))	3/8

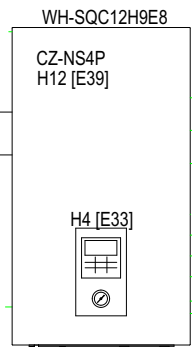
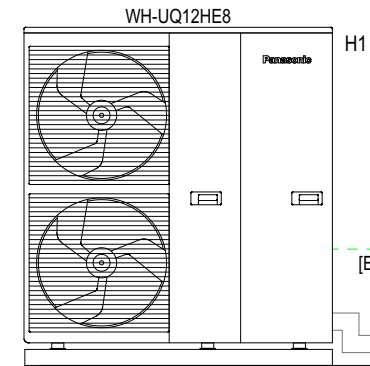

CZ-TAW1B [E64]

PAW-A2W-TSOD [E36]

230 V [E62]

230 V [E61]

PAW-TS1/PAW-TS2 [E35]

[E30/E38]

H7

PAW-TD30C1E5HI-1

H22

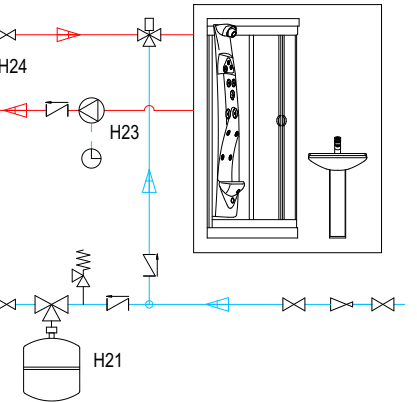

PAW-A2W-TSHC [E45]

H9 [E29/E37]

RT

H25 [E28]

H13 [E52]

H14 [E31]

H11

PAW-A2W-TSBU [E42]

H104

H5

H6

PAW-BTANK100L

H10

Hydraulic Connection	
Type	BSPP (male)
Inlet & Outlet Size (mm(in))	31.75 (1-1/4)
Min. Flow Rate (l/m)	34.4

Panasonic

2023-09-21,15:32:38

WH-SQC12H9E8 + WH-UQ12HE8

Anlagenbeispiel

Anlagenbeispiel

Anlagenbeispiel

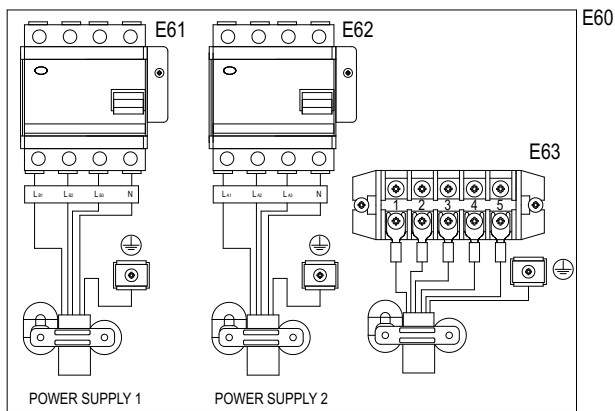
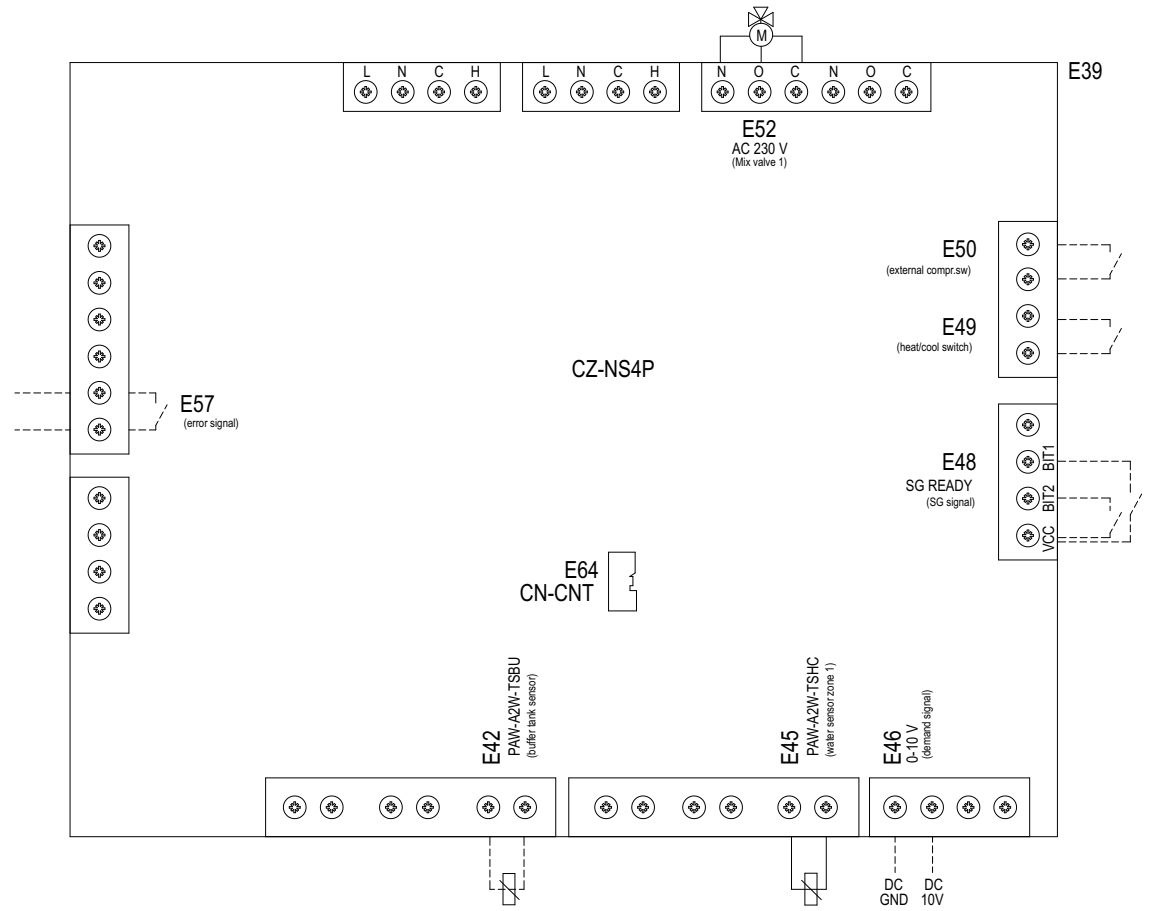
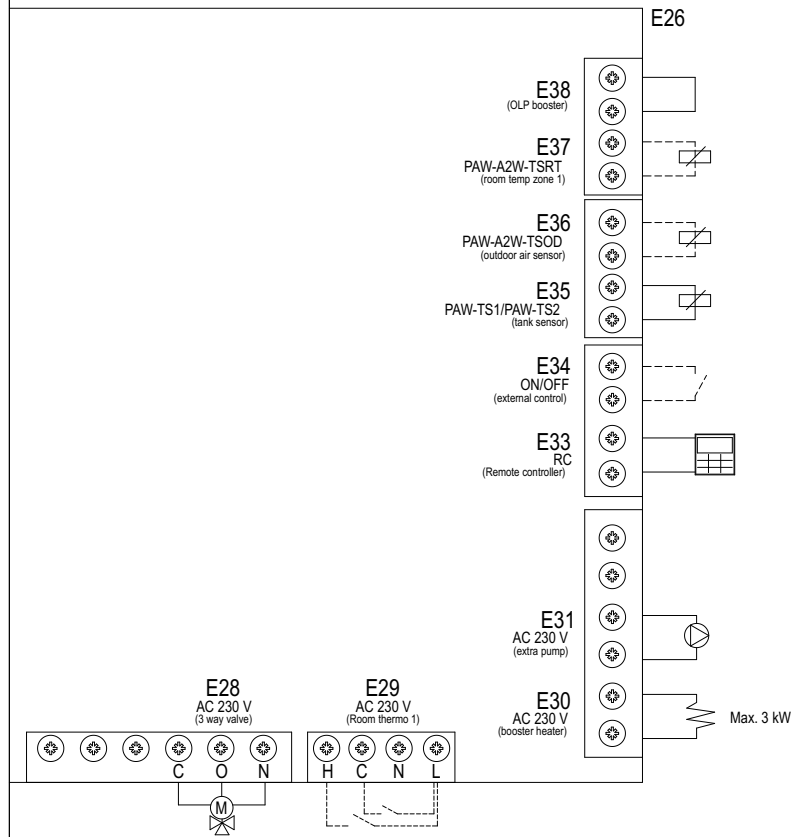

Liste der Systemkomponenten

Panasonic Components

REF	CODE	NR	DESCRIPTION
H1	WH-UQ12HE8	1	Außengerät [12, E8]
H2	WH-SQC12H9E8	1	Hydromodul (4) [12, E8]
H9	PAW-A2W-TSRT	1	Raum-Temperaturfühler (optional) (1)
H10	PAW-BTANK100L	1	Pufferspeicher
H12	CZ-NS4P	1	Zusatzplatine für Wärmepumpen der H- und J-Generation
H24	PAW-TD30C1E5HI-1	1	Standard-WW-Speicher (einschl. Temperaturfühler PAW-TS2) (2)
H25	CZ-NV1	1	3-Wege-Umschaltventil-Set für Einbau in Hydromodule (3)
H25	PAW-3WYVLV-HW	1	3-Wege-Umschaltventil für Warmwasserspeicher (3)
E36	PAW-A2W-TSOD	1	Außen-Temperaturfühler (optional)
---	PAW-GRDBSE20	1	Dämpfungssockel-Set für Außengeräte (optional)
---	CZ-NE3P	1	Zusatz-Gehäuseheizung (optional)
E42	PAW-A2W-TSBU	1	Pufferspeicher-Temperaturfühler
E64	CZ-TAW1B	1	Interface für Internetsteuerung mit Aquarea Smart Cloud (optional)
E45	PAW-A2W-TSHC	1	Heizkreis- und Schwimmbad-Temperaturfühler (erforderlich)

Third Party Components











REF	CODE	NR	DESCRIPTION
H5	Rückflussverhinderer	1	Erforderlich für Frankreich und Belgien, optional in den übrigen Ländern
H6	Ausdehnungsgefäß	1	Falls erforderlich
H9	Raumthermostat	1	Optional (1)
H13	Mischventil	1	Zum Heruntermischen der Wassertemperatur
H14	Heizungspumpe	1	Je nach Systemanforderungen
H21	Kaltwasser-Ausdehnungsgefäß	1	Je nach Systemanforderungen
---	Sicherheitsventil	1	Je nach Systemanforderungen
H23	Zirkulationspumpe	1	Falls erforderlich
---	Timer	1	Zur Steuerung der evtl. vorhandenen Zirkulationspumpe

Footnotes

1	Für jede Zone kann entweder ein Raum-Temperaturfühler oder ein Raumthermostat verwendet werden, nicht beide zusammen.
2	Der Warmwasserspeicher ist projektbezogen auszulegen.
3	Es kann jeweils eines der beiden aufgeführten 3-Wege-Ventile oder ein Fremdprodukt verwendet werden.
4	Im Normalbetrieb sollte der Wasserdruck zwischen 0,5 und 3 bar betragen.

LEGEND - split system

Panasonic

Legend for the hydraulic part		Legend for the electric part	
H1	Split heat pump outdoor unit (provide outdoor unit drain)	E26	Main board PCB: the maximum cable length for sensor inputs is 30 meters and the maximum cable length for outputs and other inputs is 50 meters.
H2	Split heat pump indoor unit: the Y filter and the flow meter are included in all H generation heat pumps.	E27	2 way valve: open for heating and close for cooling
H3	The refrigerant inside the HPs is R410A. For all split units the refrigerant pipes maximum length is 30 m with 20 m maximum of height difference between indoor and outdoor unit. The 3 and 5 kW LT units have a 15 m maximum length and 5 maximum height difference. For all size HPs the minimum distance between indoor and outdoor unit is 3m.	E28	3 way valve: open for DHW and close for heating/cooling system
H4	Remote controller of the Heat pump.	E29	Optional thermostat 1: every circuit can be controlled with one optional thermostat (E29 for one zone and E53 and E54 for 2 zones), with one room sensor (E37 for one zone or E40 and E41 for 2 zones) or with the remote controller (E 33, only for 1 circuit).
H104	Magnetic filter (recommended)		
H5	System charge and Backflow		
H6	Expansion vessel: every HP has a 10 litre expansion vessel that will cater for 200 litres at 55°C in the fully open heat pump circuit. Any variation, greater than the specification stated, will require a secondary expansion vessel added to the system.	E30	Booster heater
H7	Electrical connections: to be defined when the hydraulic scheme and the system control logic have been selected.	E31	Extra pump control
H8	Overflow valve	E32	ON/OFF boiler (dry contact)
H9	Optional thermostat: every circuit can be controlled with one optional thermostat, with one room sensor or with the remote controller (only for 1 circuit).	E33	Remote Controller: the H generation heat pump remote controller can be used as a room thermostat for only one circuit. The cables maximum length is 50 meters.
H10	Buffer tank / Volumiser: in the open primary circuit (when all heating - cooling circuits are closed) it is recommended a minimum water volume of at least 30 litres up to and including 9 kW units and 50 litres for 12 & 16kW (kW stated is nominal heating capacity of the heat pump A7/W35).	E34	External ON/OFF (dry contact)
		E35	DHW tank sensor
H11	Heating/cooling circuit: If the HP is connected directly to the system, the minimum water flow rate must be guaranteed. Provide an overflow valve (recommended 1" diameter) or a 3-way diverting valve on hydronic indoor units (fan-coil, duct unit etc), or a thermostat must be removed to ensure sufficient flow. If you have floor heating provide a safety thermostat (for heating mode) and a dew-point sensor (for cooling mode).	E36	Outdoor air sensor (optional)
		E37	Zone 1 room sensor (see point E29)
H12	Optional PCB - CZ-NS4P - needed for this scheme	E38	OLP booster heater: on the OLP contact must be put a jumper if external booster heater is used and controlled by Panasonic heat pumps.
H13	Mix valve with 3 points control	E39	Optional PCB: the maximum cable length for sensor inputs is 30 meters and the maximum cable length for outputs and other inputs is 50 meters. If the optional PCB (CZ-NS4P) is installed, the external room thermostat 1, the room sensor 1 and the extra pump control contacts of the main board PCB are disabled.
H14	Secondary water pump: they must be chosen according to the system hydraulic performance.		
H15	Boiler	E40	Zone 2 room sensor (see point E29)
H16	Solar panels	E41	Zone 1 room sensor (see point E29)
H17	Solar pump	E42	Buffer tank sensor
H18	Pool pump	E43	Pool water sensor
H19	Heat exchanger for the swimming pool (to be sized)	E44	Water sensor zone 2 (see point E29)
H20	Swimming pool	E45	Water sensor zone 1 (see point E29)
H21	Expansion vessel (cold water)	E46	Demand signal (0-10 V)
H22	Sanitary equipment	E47	Solar sensor
H23	Circulation pump (optional) and timer	E48	Smart Grid signal: the 2 contacts can increase the set-point for DHW and heating if there is energy production from the PV panels.
H24	Domestic hot water tank: If the DHW tank is supplied by Panasonic the DHW temperature sensor is included. If not it is necessary to order one of the following codes: CZ-TK1 (sensor with 20 meter sensor cable and copper pocket) or PAW-TS1 / PAW-TS2 (sensor with 6/20 meter sensor cable). PAW-TG15C1EZ tank doesn't have the circulation connection, if this tank is installed, the circulation pipe must be connected to the cold water inlet pipe.	E49	Heat / cool switch
		E50	External compressor switch
H25	3 way valve: it is possible to install the Panasonic 3 way valve inside the indoor unit (code CZ-NV1) or outside the indoor unit (code PAW-3WYVLV-SI). The DHW temperature sensor must be ordered separately (see point E24).	E51	Mixing valve zone 2
	Shut-off valve	E52	Mixing valve zone 1
	Non-return valve	E53	Optional thermostat 1 (see point E29)
	Security valve	E54	Optional thermostat 2 (see point E29)
	Thermostatic mixing valve	E55	Pool pump
	Pressure regulator	E56	Solar pump
	Boiler circuit pipes	E57	Error signal (dry contact)
	Solar panels circuit pipes	E58	Pump zone 1
	Pipes	E59	Pump zone 2
	Domestic cold water pipe	E60	Indoor unit power supply
	Circulation circuit pipes	E61	Indoor unit power supply 1 - main
	Electrical wired cables	E62	Indoor unit power supply 2 - heaters
		E63	Connection to the outdoor unit: the outdoor unit power supply comes from the indoor unit, so it is not necessary to bring a direct power supply to the outdoor unit.

Attention: All requirements in this page are only examples and they are not a project design specific. Refer always to the documentation provided by Panasonic. Panasonic is not responsible, directly or indirectly, towards users and in general towards any third party for any delays, inaccuracies, errors, omissions, damages (direct, indirect, consequential, and punishable) arising from such contents. Texts, photos, graphics, may not be published, rewritten, marketed and distributed by users and third parties in general, in any way and in any form if not expressly indicated in written form by Panasonic itself.

Panasonic

heating & cooling solutions

Elektrisches Anschlussschema für 3-Wege Zonenventil MultiZone 3W Set von LK Armatur

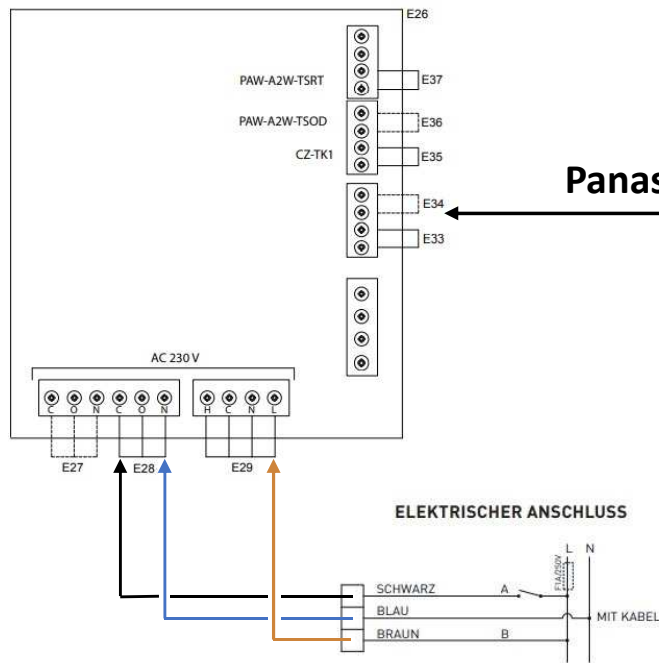

Panasonic Hauptplatine

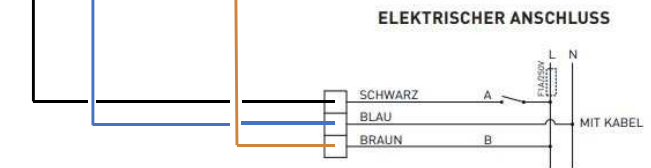
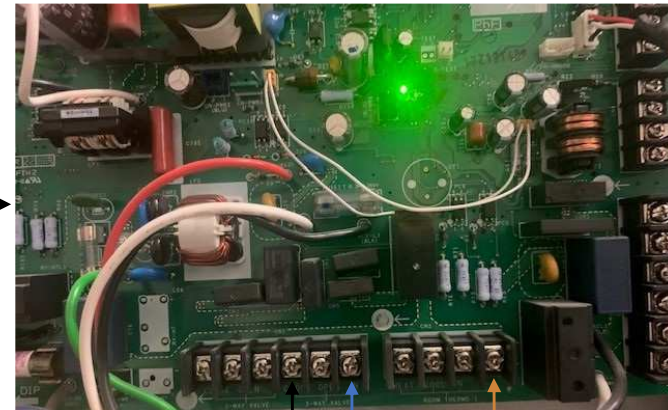

LK Armatur MultiZone 3W Set, DN25 1" AG
Alternativprodukt zu Panasonic
3-Wege Umschaltventil PAW-3WYVLV-HW

